

STATE OF NORTH CAROLINA/BUNCOMBE COUNTY SCHOOLS REQUEST FOR PROPOSAL

RFP #42-12

PROJECT: Valley Springs Middle PEP Canopy

PROJECT DESIGNER: Tim Fierle, AIA, Director of Facilities

USING AGENCY: Buncombe County Schools

ISSUE DATE: October 29, 2012

Sealed proposals subject to the conditions made a part hereof will be received until **4:00 p.m., Wednesday, November 14, 2012** for furnishing all labor, materials, equipment, and services incidental and implied, for completion of the project described herein.

PREBID CONFERENCE: No PreBid Meeting will be held. Contractors are encouraged to visit the site and submit any technical questions to the Designer (Tripp Anderson), bidding questions to the Purchasing Officer (Ron Venturella) and other questions to the Owner (Tim Fierle). Contractors shall check in with the school's main office upon arrival to the site.

SEND **ALL** PROPOSALS DIRECTLY TO THE ADDRESS AS SHOWN BELOW:

Buncombe County Schools, Purchasing Division

175 Bingham Road
Asheville, NC 28806

NOTE: Indicate firm name and RFP number on the front of each sealed proposal envelope or package, along with the date for receipt of proposals specified above.

Direct inquiries concerning this RFP to:

Tim Fierle, Director of Facilities	Phone: 828-255-5916
Tripp Anderson, Designer	Phone: 828-989-5154
Ron Venturella, Purchasing Officer	Phone: 828-255-5891

THE PROCUREMENT PROCESS

The following is a general description of the process by which a firm will be selected to provide services.

1. Request for Proposals (RFP) is issued to prospective contractors.
2. A preproposal conference and/or deadline for written questions is five days prior to due date.
3. Proposals in one original will be received from each offeror in a sealed envelope or package. Each original shall be signed and dated by an official authorized to bind the firm. Unsigned proposals will not be considered.
4. All proposals must be received by the issuing agency not later than the date and time specified on the cover sheet of this RFP.
5. At that date and time the proposals from each responding firm will be opened. Interested parties are cautioned that these costs and their components are subject to further evaluation for completeness and correctness and therefore may not be an exact indicator of an offeror's pricing position. Informal proposals (less than \$ 300,000) are confidential until such time that award has been made. Thereafter, the purchasing division will furnish bid tabs upon request.
6. At their option, the evaluators may request oral presentations or discussion with any or all offerors for the purpose of clarification or to amplify the materials presented in any part of the proposal. However, offerors are cautioned that the evaluators are not required to request clarification; therefore, all proposals should be complete and reflect the most favorable terms available from the offeror.
7. Proposals will be evaluated according to completeness, content, experience with similar projects, ability of the offeror and its staff, and cost. Award of a contract to one offeror does not mean that the other proposals lacked merit, but that, all factors considered, the selected proposal was deemed most advantageous to the State.
8. Offerors are cautioned that this is a request for offers, not a request to contract, and the State/Buncombe County Schools reserves the unqualified right to reject any and all offers when such rejection is deemed to be in the best interest of the State.

(NOTE: THE PROPOSAL FORM MUST BE FULLY EXECUTED AND RETURNED FOR CONSIDERATION)

PROPOSAL FORM

Valley Springs Middle PEP Canopy

RFP#42-12

DUE DATE: 11-14-12

By submitting this proposal, the potential contractor certifies the following:

- ** This proposal is signed by an authorized representative of the firm.
- ** It can obtain and submit to the Owner insurance certificates as required within 5 calendar days after notice of award.
- ** The cost and availability of all equipment, materials, and supplies associated with performing the services described herein have been determined and included in the proposed cost.
- ** All labor costs, direct and indirect, have been determined and included in the proposed cost.
- ** All taxes have been determined and included in the proposed cost.
- ** The offeror has attended the conference (*if applicable*) or conducted a site visit and is aware of prevailing conditions associated with performing these services.
- ** The potential contractor has read and understands the conditions set forth in this RFP and agrees to them with no exceptions.

Therefore, in compliance with this Request for Proposals, and subject to all conditions herein, the undersigned offers and agrees, if this proposal is accepted within 45 days (normally less) from the date of the opening, to furnish the subject services for a cost not to exceed:

BASE BID:
\$ _____ dollars and _____ /100 \$ _____

OFFEROR: _____

ADDRESS: _____

CITY, STATE, ZIP: _____

TELEPHONE NUMBER: _____ FAX: _____

FED ID No: _____ Type & License #: _____

E-MAIL: _____ MBE Status: _____

Principal Place of Business if different from above (See General Information on Submitting Proposals, Item 18.): _____

BY: (Signature) _____ TITLE: _____

DATE: _____ (Typed or printed name) _____

END OF PROPOSAL FORM

GENERAL INFORMATION ON SUBMITTING PROPOSALS

1. **EXCEPTIONS:** All proposals are subject to the terms and conditions outlined herein. All responses shall be controlled by such terms and conditions and the submission of other terms and conditions, price lists, catalogs, and/or other documents as part of an offeror's response will be waived and have no effect either on this Request for Proposals or on any contract that may be awarded resulting from this solicitation. Offeror specifically agrees to the conditions set forth in the above paragraph by signature to the proposal.
2. **CERTIFICATION:** By executing the proposal, the signer certifies that this proposal is submitted competitively and without collusion (G.S. 143-54), that none of our officers, directors, or owners of an unincorporated business entity has been convicted of any violations of Chapter 78A of the General Statutes, the Securities Act of 1933, or the Securities Exchange Act of 1934 (G.S. 143-59.2), and that we are not an ineligible vendor as set forth in G.S. 143-59.1. False certification is a Class I felony.
3. **ORAL EXPLANATIONS:** The State/Buncombe County Schools shall not be bound by oral explanations or instructions given at any time during the competitive process or after award.
4. **REFERENCE TO OTHER DATA:** Only information which is received in response to this RFP will be evaluated; reference to information previously submitted shall not be evaluated.
5. **ELABORATE PROPOSALS:** Elaborate proposals in the form of brochures or other presentations beyond that necessary to present a complete and effective proposal are not desired.

In an effort to support the sustainability efforts of the State of North Carolina we solicit your cooperation in this effort.

It is desirable that all responses meet the following requirements:

- All copies are printed **double sided**.
 - All submittals and copies are printed on **recycled paper with a minimum post-consumer content of 30%** and indicate this information accordingly on the response.
 - Unless absolutely necessary, all proposals and copies should **minimize or eliminate use of non-recyclable or non re-usable materials** such as plastic report covers, plastic dividers, vinyl sleeves, and GBC binding. Three-ringed binders, glued materials, paper clips, and staples are acceptable.
 - Materials should be submitted in a format which allows for **easy removal and recycling** of paper materials.
6. **COST FOR PROPOSAL PREPARATION:** Any costs incurred by offerors in preparing or submitting offers are the offerors' sole responsibility; the State of North Carolina/Buncombe County Schools will not reimburse any offeror for any costs incurred.
 7. **TIME FOR ACCEPTANCE:** Each proposal shall state that it is a firm offer which may be accepted within a period of 45 days. Although the contract is expected to be awarded prior to that time, the 45 day period is requested to allow for unforeseen delays.
 8. **TITLES:** Titles and headings in this RFP and any subsequent contract are for convenience only and shall have no binding force or effect.
 9. **CONFIDENTIALITY OF PROPOSALS:** In submitting its proposal the offeror agrees not to discuss or otherwise reveal the contents of the proposal to any source outside of the using or issuing agency, government or private, until after the award of the contract. Offerors not in compliance with this provision may be disqualified, at the option of the State/Buncombe County Schools, from contract award. Only discussions authorized by the issuing agency are exempt from this provision.
 10. **RIGHT TO SUBMITTED MATERIAL:** All responses, inquiries, or correspondence relating to or in reference to the RFP, and all other reports, charts, displays, schedules, exhibits, and other documentation submitted by the offerors shall become the property of the State/Buncombe County Schools when received.
 11. **OFFEROR'S REPRESENTATIVE:** Each offeror shall submit with its proposal the name, address, and telephone number of the person(s) with authority to bind the firm and answer questions or provide clarification concerning the firm's proposal.
 12. **SUBCONTRACTING:** Offerors may propose to subcontract portions of the work provided that their proposals clearly indicate what work they plan to subcontract and to whom and that all information required about the prime contractor is also included for each proposed subcontractor.
 13. **PROPRIETARY INFORMATION:** Trade secrets or similar proprietary data which the offeror does not wish disclosed to other than personnel involved in the evaluation or contract administration will be kept confidential to the extent permitted by NCAC T01:05B.1501 and G.S. 132-1.3 if identified as follows: Each page shall be identified in boldface at the top and bottom as "CONFIDENTIAL". Any section of the proposal which is to remain confidential shall also be so marked in boldface on the title page of that section. Cost information may not be deemed confidential. In spite of what is labeled as confidential, the determination as to whether or not it is shall be determined by North Carolina law.

14. **HISTORICALLY UNDERUTILIZED BUSINESSES:** Pursuant to General Statute 143-48 and Executive Order #150, Buncombe County Schools invites and encourages participation in this procurement process by businesses owned by minorities, women, disabled, disabled business enterprises and non-profit work centers for the blind and severely disabled.

The Contractor agrees in particular to maintain open hiring and employment practices and to receive applications for employment in compliance with all requirements of applicable federal, state and local laws and regulations issued pursuant thereto relating to nondiscriminatory hiring and employment practices. Each Prime Contractor shall undertake an affirmative action program to ensure that no person shall be excluded from participation in any employment activities because of age, sex, race, religion, color, national origin or handicap.

15. **PROTEST PROCEDURES:** If an offeror wants to protest a contract awarded pursuant to this solicitation, they must submit a written request to the Purchasing Officer, Buncombe County Schools, 175 Bingham Road, or PO Box 16771, Asheville, NC 28806. This request must be received by the Purchasing Division within thirty (30) consecutive calendar days from the date of the contract award, and must contain specific sound reasons and any supporting documentation for the protest. **NOTE:** Contract award notices are sent only to those actually awarded contracts, and not to every person or firm responding to this solicitation. Contract status and award notices are available through the purchasing division or the project designer with contact information as shown on the first page of this solicitation. Offeror's may call to obtain a verbal status of contract award. All protests will be handled pursuant to the North Carolina Administrative Code, Title 1, Department of Administration, Chapter 5, Purchase and Contract, Section 5B.1519.
16. **TABULATIONS:** Offeror's may call the purchasing division to obtain a verbal status of contract award.
17. **VENDOR REGISTRATION AND SOLICITATION NOTIFICATION SYSTEM:** Vendor Link NC allows vendors to electronically register free with the State to receive electronic notification of current procurement opportunities for goods and services available on the Interactive Purchasing System. Online registration and other purchasing information are available on the Internet web site: <http://www.state.nc.us/pandc/>.
18. **RECIPROCAL PREFERENCE:** G.S. 143-59 establishes a reciprocal preference law to discourage other states from applying in-state preferences against North Carolina's resident offerors. The "Principal Place of Business" is defined as the principal place from which the trade or business of the offeror is directed or managed.

NORTH CAROLINA GENERAL CONTRACT TERMS AND CONDITIONS (Contractual and Consultant Services)

1. **GOVERNING LAW:** This contract is made under and shall be governed and construed in accordance with the laws of the State of North Carolina.
2. **SITUS:** The place of this contract, its situs and forum, shall be North Carolina, where all matters, whether sounding in contract or tort, relating to its validity, construction, interpretation and enforcement shall be determined.
3. **INDEPENDENT CONTRACTOR:** The Contractor shall be considered to be an independent contractor and as such shall be wholly responsible for the work to be performed and for the supervision of its employees. The Contractor represents that it has, or will secure at its own expense, all personnel required in performing the services under this agreement. Such employees shall not be employees of, or have any individual contractual relationship with the Agency.
4. **KEY PERSONNEL:** The Contractor shall not substitute key personnel assigned to the performance of this contract without prior written approval by the Agency's Contract Administrator. The individuals designated as key personnel for purposes of this contract are those specified in the Contractor's proposal.
5. **SUBCONTRACTING:** Work proposed to be performed under this contract by the Contractor or its employees shall not be subcontracted without prior written approval of the Agency's Contract Administrator/Project Designer. Acceptance of an offeror's proposal shall include any subcontractor(s) specified therein.
6. **PERFORMANCE AND DEFAULT:** If, through any cause, the Contractor shall fail to fulfill in timely and proper manner the obligations under this agreement, the Agency shall thereupon have the right to terminate this contract by giving written notice to the Contractor and specifying the effective date thereof. In that event, all finished or unfinished deliverable items under this contract prepared by the Contractor shall, at the option of the Agency, become its property, and the Contractor shall be entitled to receive just and equitable compensation for any satisfactory work completed on such materials. Notwithstanding, the Contractor shall not be relieved of liability to the Agency for damages sustained by the Agency by virtue of any breach of this agreement, and the Agency may withhold any payment due the Contractor for the purpose of setoff until such time as the exact amount of damages due the Agency from such breach can be determined.
In case of default by the Contractor, the State may procure the services from other sources and hold the Contractor responsible

for any excess cost occasioned thereby. The State reserves the right to require performance bond or other acceptable alternative guarantees from successful offeror without expense to the State.

Upon the entering of a judgment of bankruptcy of insolvency by or against the Contractor, the Agency may terminate this contract for cause.

Neither party shall be deemed to be in default of its obligations hereunder if and so long as it is prevented from performing such obligations by any act of war, hostile foreign action, nuclear explosion, riot, strikes, civil insurrection, earthquake, hurricane, tornado, or other catastrophic natural event or act of God.

7. **TERMINATION:** The Agency may terminate this agreement at any time by *15 days* notice in writing from the Agency to the Contractor. In that event, all finished or unfinished deliverable items prepared by the Contractor under this contract shall, at the option of the Agency, become its property. If the contract is terminated by the Agency as provided herein, the Contractor shall be paid for services satisfactorily completed, less payment or compensation previously made.
8. **AVAILABILITY OF FUNDS:** Any and all payments to the Contractor are dependent upon and subject to the availability of funds to the Agency for the purpose set forth in this agreement.
9. **CONFIDENTIALITY:** Any information, data, instruments, documents, studies or reports given to or prepared or assembled by the Contractor under this agreement shall be kept as confidential and not divulged or made available to any individual or organization without the prior written approval of the Agency.
10. **CARE OF PROPERTY:** The Contractor agrees that it shall be responsible for the proper custody and care of any property furnished it for use in connection with the performance of this contract or purchased by it for this contract and will reimburse the State for loss of damage of such property.
11. **COPYRIGHT:** No deliverable items produced in whole or in part under this agreement shall be the subject of an application for copyright by or on behalf of the Contractor.
12. **ACCESS TO PERSONS AND RECORDS:** The State Auditor shall have access to persons and records as a result of all contracts or grants entered into by State agencies or political subdivisions in accordance with General Statute 147-64.7. The Contractor shall retain all records for a period of three years following completion of the contract.
13. **ASSIGNMENT:** No assignment of the Contractor's obligations nor the Contractor's right to receive payment hereunder shall be permitted. However, upon written request approved by the issuing purchasing authority, the State may:
 - a. Forward the contractor's payment check(s) directly to any person or entity designated by the Contractor, or
 - b. Include any person or entity designated by Contractor as a joint payee on the Contractor's payment check(s).In no event shall such approval and action obligate the State to anyone other than the Contractor and the Contractor shall remain responsible for fulfillment of all contract obligations.
14. **COMPLIANCE WITH LAWS:** The Contractor shall comply with all laws, ordinances, codes, rules, regulations, and licensing requirements (permits) that are applicable to the conduct of its business, including those of federal, state, and local agencies having jurisdiction and/or authority.
15. **AFFIRMATIVE ACTION:** The Contractor shall take affirmative action in complying with all Federal and State requirements concerning fair employment and employment of people with disabilities, and concerning the treatment of all employees without regard to discrimination by reason of race, color, religion, sex, national origin, or disability.
16. **INSURANCE:** During the term of the contract, the contractor at its sole cost and expense shall provide commercial insurance of such type and with such terms and limits as may be reasonably associated with the contract. As a minimum, the contractor shall provide and maintain the following coverage and limits:
 - a. Worker's Compensation - The contractor shall provide and maintain Worker's Compensation Insurance, as well as employer's liability coverage with minimum limits of \$150,000.00, covering all of Contractor's employees who are engaged in any work under the contract. If any work is subcontracted, the contractor shall require the subcontractor to provide the same coverage for any of its employees engaged in any work under the contract.
 - b. Commercial General Liability - General Liability Coverage on a Comprehensive Broad Form on an occurrence basis in the minimum amount of \$2,000,000.00 Combined Single Limit. (Defense cost shall be in excess of the limit of liability).
 - c. Automobile - Automobile Liability Insurance, to include liability coverage, covering all owned, hired and non-owned vehicles, used in connection with the contract. The minimum combined single limit shall be \$500,000.00 bodily injury and property damage; \$500,000.00 uninsured/under insured motorist; and \$100,000.00 medical payment.

Providing and maintaining adequate insurance coverage is a material obligation of the contractor and is of the essence of this contract. All such insurance shall meet all laws of the State of North Carolina. Such insurance coverage shall be obtained from companies that are authorized to provide such coverage and that are authorized by the Commissioner of Insurance to do business in North Carolina. The contractor shall at all times comply with the terms of such insurance policies, and all requirements of the insurer under any such insurance policies, except as they may conflict with existing North Carolina laws or this contract. The limits of coverage under each insurance policy maintained by the contractor shall not be interpreted as limiting the contractor's liability and obligations under the contract.

The Contractor shall furnish a Certificate of Insurance as proof of the above coverages. Certificate will contain provision that the insurance coverages cannot be canceled, reduced in amount or coverage eliminated without 30 days written notice to the Buncombe County Board of Education. Owner's Protective insurance must list the Buncombe County Board of Education as a "Named Insured" as it's interest may appear. Owner's approval of Certificate of Insurance does not decrease or relieve the contractor's responsibility for maintaining insurance coverage as required in this Request for Proposal.

17. **ADVERTISING:** Contractor agrees not to use the existence of this contract, the name of the agency, or the name of the State of North Carolina as part of any commercial advertising.
18. **ENTIRE AGREEMENT:** This contract and any documents incorporated specifically by reference represent the entire agreement between the parties and supersede all prior oral or written statements or agreements. This Request for Proposals, any addenda thereto, and the offeror's proposal are incorporated herein by reference as though set forth verbatim.

All promises, requirements, terms, conditions, provisions, representations, guarantees, and warranties contained herein shall survive the contract expiration or termination date unless specifically provided otherwise herein, or unless superseded by applicable Federal or State statutes of limitation.

19. **AMENDMENTS:** This contract may be amended only by written amendments duly executed by the Agency and the Contractor.
20. **TAXES:** G.S. 143-59.1 bars the Secretary of Administration from entering into contracts with vendors if the vendor or its affiliates meet one of the conditions of G. S. 105-164.8(b) and refuse to collect use tax on sales of tangible personal property to purchasers in North Carolina. Conditions under G. S. 105-164.8(b) include: (1) Maintenance of a retail establishment or office, (2) Presence of representatives in the State that solicit sales or transact business on behalf of the vendor and (3) Systematic exploitation of the market by media-assisted, media-facilitated, or media-solicited means. By execution of the bid document the vendor certifies that it and all of its affiliates, (if it has affiliates), collect(s) the appropriate taxes.
21. **GENERAL INDEMNITY:** The contractor shall hold and save the State/Buncombe County Schools, its officers, agents, and employees, harmless from liability of any kind, including all claims and losses, with the exception of consequential damages, accruing or resulting to any other person, firm, or corporation furnishing or supplying work, services, materials, or supplies in connection with the performance of this contract, and from any and all claims and losses accruing or resulting to any person, firm, or corporation that may be injured or damaged by the contractor in the performance of this contract and that are attributable to the negligence or intentionally tortious acts of the contractor provided that the contractor is notified in writing within 30 days that the State/Buncombe County Schools has knowledge of such claims. The contractor represents and warrants that it shall make no claim of any kind or nature against the State's agents who are involved in the delivery or processing of contractor goods to the State. The representation and warranty in the preceding sentence shall survive the termination or expiration of this contract.

CONTRACTOR'S SALES TAX REPORT
NC State and Local Sales Taxes Paid

Buncombe County Schools

CONTRACTOR: _____ **PO#/RFP#** _____

Address: _____ **For Period:** _____

Invoice Date	Invoice #	Type of Property	NC Tax 4.75%	County Tax 2.00%	Name of County
		TOTAL	\$	\$	

I certify that the above figures do not include any tax paid on supplies, tools and equipment which were used to perform this contract and only includes those building materials, supplies, fixtures and equipment which actually became a part of or annexed to the building or structure. I certify that, to the best of my knowledge, the information provided here is true, correct, and complete.

Sworn to and subscribed before me,

This the _____ day of _____, 20____

Signed

Notary Public

My Commission Expires: _____

Print or Type Name of Above & Title

Seal

NOTE:
This certified statement may be subject to audit.

The North Carolina General Assembly has amended the Statute to provide refunds of sales and use tax to local school units in accordance with the provisions of G.S. 105-164. 14(c) effective with tax paid on or after July 1, 1998.

These refunds are to include the "sales and use taxes paid by contractors on building materials, supplies, fixtures and equipment that become a part of or annexed to a building or structure that is owned or leased by the governmental entity and is being erected, altered or repaired for use by the governmental entity (G.S. 105-164.14)."

Sales and Use Tax Technical Bulletin Section 18-2F specifies: "To substantiate a refund claim for sales or use taxes paid on purchases of building materials, supplies, fixtures and equipment by its contractor, the claimant must secure from such contractor certified statements setting forth all of the following information:

- a. the date the property was purchased;
- b. the type of property purchased :
- c. the project for which the property was used:
- d. if the property was purchased in this State, the county in which it was purchased;
- e. if the property was not purchased in this State, the county in which the property was used; and
- f. the amount of sales and use taxes paid.

In the event the contractor makes several purchases from the same vendor, such certified statement must indicate the invoice numbers, the inclusive dates of the invoices, the total amount of the invoices and the State and local sales and use taxes paid thereon. Such statement must also include the cost of any tangible personal property withdrawn from the contractor's warehouse stock and the amount of sales and use tax paid thereon by the contractor. Similar certified statements by his subcontractors must be obtained by the general contractor and furnished to the claimant. Any local sales or use taxes must be shown separately from the State sales or use taxes. The contractor's statements must not contain sales or use taxes paid on purchases of tangible personal property purchased by such contractors for use in performing the contract which does not annex to, affix to or in some manner become a part of the building or structure that is owned or leased by a governmental agency and is being erected, altered or repaired for use by a governmental entity as defined by G.S. 105-164.14(c). Examples of property on which sales or use tax has been paid by the contractor and which shall not be included in the contractor's statement are scaffolding, forms for concrete, fuel for the operation of machinery and equipment, tools, repair parts and equipment rentals.

Please read entire specification package. You will be held accountable for all information. NO payment shall be made if specifications are not followed.

Scope: Fabrication and installation of a new freestanding pre-engineered outdoor canopy structure to be installed adjacent to the existing bus drop-off at the side entry of Valley Springs Middle School at 224 Long Shoals Road, Arden, NC 28704. Minor demolition of sidewalk concrete will be required for installation of new concrete footings for the canopy, and sidewalk patching will be required after canopy erection.

Work Schedule: Work may be completed on good weather days as defined in the specifications and as coordinated with school testing schedule. **Work schedule begins the date the purchase order is issued** and is to be completed by April 8, 2012.

Qualifications: All bidders must furnish a list of North Carolina Contractor Licenses, which they hold.

Contractor's Responsibility: The Contractor shall be responsible for the construction site during the performance of the work. The Contractor shall be responsible for any and all damages to persons and property during the performance of the work and shall further provide all necessary safety measures and shall fully comply with all federal state and local laws, building rules, rules and regulations to prevent accidents or injury to persons or property on or about the location of the work site. This is to include OSHA 1910, General Construction, or those regulations mandated by these specifications. Special attention will be made to proper barricading of the work areas due to the work progressing within an actively operating office atmosphere.

Safety Regulations: The Contractor shall adhere to the rules, regulations and interpretations of the North Carolina Department of Labor relating to Occupational Safety and Health Standards for the Construction Industry (Title 29, Code of Federal Regulations, Part 1926, published in Volume 39, Number 122, Part II, June 24, 1974 Federal Register) which is hereby incorporated in these specifications.

Codes: All work shall be done in accordance with the specifications and shall comply with North Carolina Building Code, Underwriters' Rules and Regulations and Federal, State and Local Regulations covering work of this nature. Whenever drawings or specifications are in excess of such laws, codes and regulations, the specifications shall hold. All equipment shall have U. L. labels attached.

Permits: **The Contractor must secure all permits required for the job completion**, obtain and deliver to Owner, all certification of inspection issued by the authorities having jurisdiction, with Contractor paying cost of same.

Workers on Job: All employees of the Contractor shall, while on Buncombe County Board of Education property, act in a professional and courteous manner. All workers shall be expected to wear long pants and shirts while on Board property. Also, all employees of the Contractor must "sign in" in the main office upon entering the facility and must "sign out" upon leaving the property. Any employee of the Contractor may be told to leave the property by either the Principal or the Assistant Director, if they do not follow the above procedure. The employee shall be replaced with another at no additional cost to the Buncombe County Board of Education.

In accordance with G.S. 14-208.18, all persons who (1) are required to register under the Sex Offender and Public Protection Program AND (2) have been convicted of certain sexually violent offenses or any offense where the victim was under the age of 16 years at the time of the offense are expressly forbidden to knowingly be present on any property owned or operated by the school system, including school buildings, athletic fields, playgrounds, parking lots, school buses, activity buses or other

property of any kind for any reason, including attendance at sporting events or other school related functions, whether before, during or after school hours. It is the responsibility of the contractor or vendor that their employees and sub-contractors are in accordance with G.S. 14-208.18.

Equipment and Tools: The Contractor shall use no equipment or tools that are owned by the Buncombe County Board of Education. Also, no employees of the Buncombe County Board of Education shall be utilized by the Contractor except for opening locked doors and giving directions.

Materials: No materials shall be stored on site and the Buncombe County Board of Education is not responsible for any materials, equipment or tools lost or stolen from the site.

Clean Up: The area of work shall be cleaned daily so that the Buncombe County Board of Education shall not incur any additional costs to make the area suitable for the work process. Also, the Contractor shall utilize no trash receptacles or dumpsters owned by the Buncombe County Board of Education. All trash and removed materials shall be properly disposed of off the property.

Performance of Work: All work shall be performed at the highest level of quality. The Owner shall be responsible for determining the quality of work, and may notify the Contractor of same. **ANY WORK COMPLETED THAT IS NOT SUITABLE TO THE OWNER SHALL BE REPEATED BY THE CONTRACTOR AT NO COST TO THE OWNER.** Any damage to existing area or utilities will be the responsibility of the Contractor. **NO EXCEPTIONS.**

Attachments: Two drawings (A101 & AS001).

The Buncombe County Board of Education reserves the right to reject any or all bids for any or no reason, and to waive informalities.

MATERIALS SPECIFICATIONS

1. THE CONTRACTOR SHALL FIELD VERIFY ALL EXISTING CONDITIONS INCLUDING LAYOUT, SIDEWALK ELEVATIONS AND DETAILS AND CLEARANCES. NOTIFY ARCHITECT OF ANY DISCREPANCIES IMMEDIATELY.
2. ALL WORK SHALL BE INSTALLED STRAIGHT, TRUE, AND PLUMB.
3. CANOPY SHALL BE A PRE-ENGINEERED PRE-FINISHED ALUMINUM CANOPY SYSTEM BY ONE OF THE FOLLOWING MANUFACTURERS:
 - a. Mapes Architectural Canopies; www.mapescanopies.com
 - b. Mitchell Metals LLC; www.mitchellmetals.net
 - c. Perfection Architectural Systems Inc; www.perfectionarch.com.
4. CANOPY MANUFACTURER SHALL DESIGN ENTIRE CANOPY SYSTEM, INCLUDING FOOTINGS TO MEET REQUIREMENTS AND DIMENSIONS OF ARCHITECTURAL DRAWINGS AS WELL AS ALL NC STATE BUILDING CODES.
5. CANOPY MANUFACTURER SHALL SUBMIT SHOP DRAWINGS OF CANOPY SYSTEM SHOWING PLANS, ELEVATIONS SECTIONS AND DETAILS. ALL DRAWINGS SHALL BE TO SCALE AND SIGNED AND SEALED BY AN ENGINEER REGISTERED IN THE STATE OF NC. STRUCTURAL COLUMNS AND BEAMS SHALL BE ALUMINUM TUBULAR EXTRUSION MINIMUM 0.125" THICK WITH BITUMINOUS PAINT PROTECTION BETWEEN COLUMN AND THE CONCRETE FOOTING. STRUCTURE SHALL ACCOMMODATE APPLIED LOADINGS WITHOUT OVER-STRESS OR OVER-DEFLECTION.
6. CANOPIES SHALL BE SELF DRAINING FROM DECKING. ALL JOINTS SHALL BE SEALED TO PREVENT WATER LEAKAGE. WATER OUTLET HOLES ARE TO BE CUT AT THE BOTTOM OF ALL DRAINING COLUMNS WITH DEFLECTOR PLATES INSTALLED INSIDE. NON-DRAINING COLUMNS SHALL HAVE WEEP HOLES AT TOP OF CONCRETE TO REMOVE CONDENSATION FROM POST.
7. FASCIA SHALL BE ALUMINUM EXTRUSION MINIMUM 0.070" THICK WITH RETURNED EDGES AND PREFORMED DRIP EDGES. FLASHING SHALL BE MINIMUM 0.040" THICK ALUMINUM. FASCIA AND FLASHING SHALL BE PREFINISHED TO MATCH ROOF COLOR. FASTENERS SHALL BE STAINLESS STEEL WITH NEOPRENE WASHERS.
8. CANOPY FINISH SHALL BE FACTORY APPLIED ENAMEL PER AAMA 2603. COLORS SHALL BE SELECTED BY ARCHITECT FROM MANUFACTURER'S FULL RANGE OF COLORS. ROOF SHALL BE BLUE, AND STRUCTURAL ELEMENTS SHALL BE WHITE.
9. ALL ALUMINUM JOINTS, CORNERS, AND CONNECTIONS SHALL BE TIGHT AND CLEAN.
10. ALL CONCRETE SHALL CONFORM TO ACI STANDARDS AND BE 4,000 PSI STRENGTH.

AITON
ANDERSON
ARCHITECTURE
A PROFESSIONAL CORPORATION

12 Church Street, Suite 21
Asheville, NC 28801



NEW CANOPIES FOR:
VALLEY SPRINGS MIDDLE SCHOOL
224 LONG SHOALS ROAD
ARDEN, NORTH CAROLINA

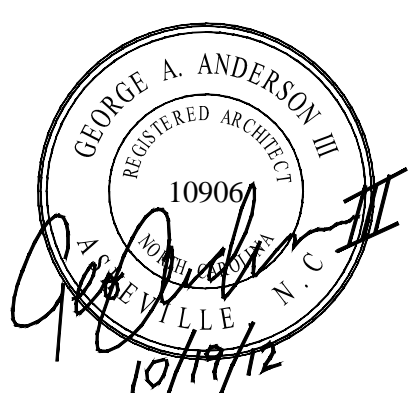

Tripp Anderson, AIA
828 989 5154
gaa@AitonAnderson.com

Issued for: PERMIT

Date: 9 OCT 2012

Job #: 12300

PLAN & DETAILS

A101

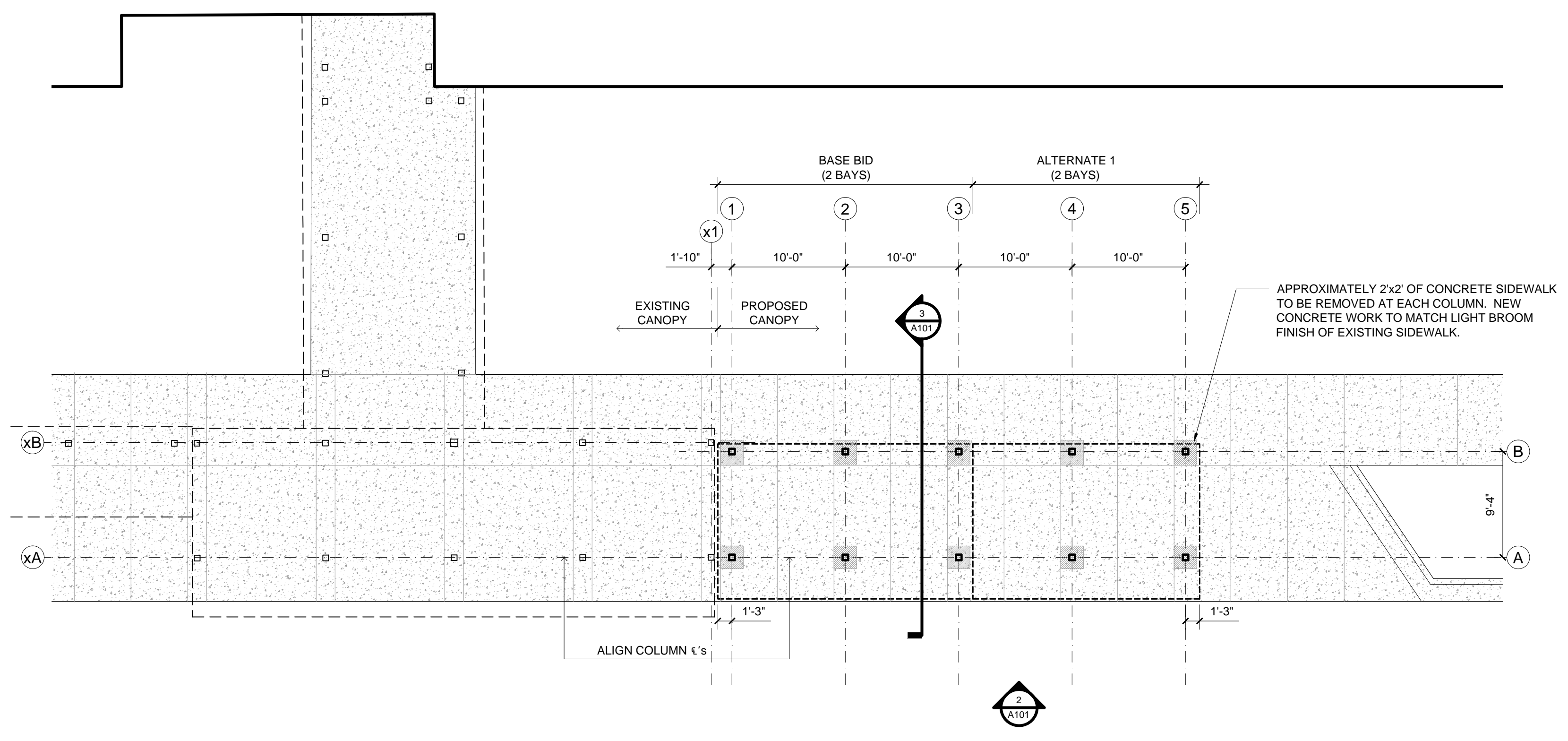

1 FLOOR PLAN
8 6 4 2 0 8 16

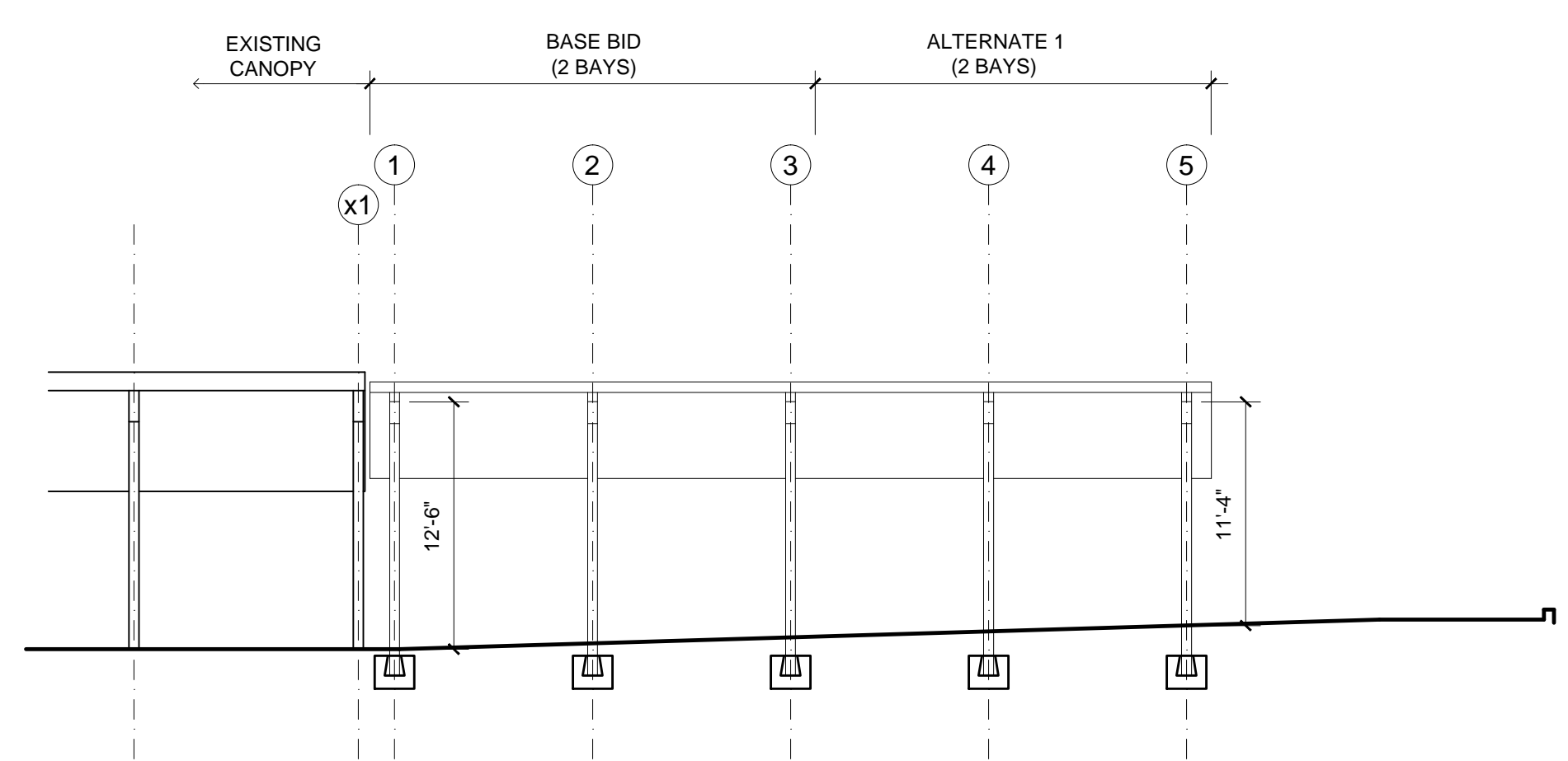

2 FRONT ELEVATION
8 6 4 2 0 8 16

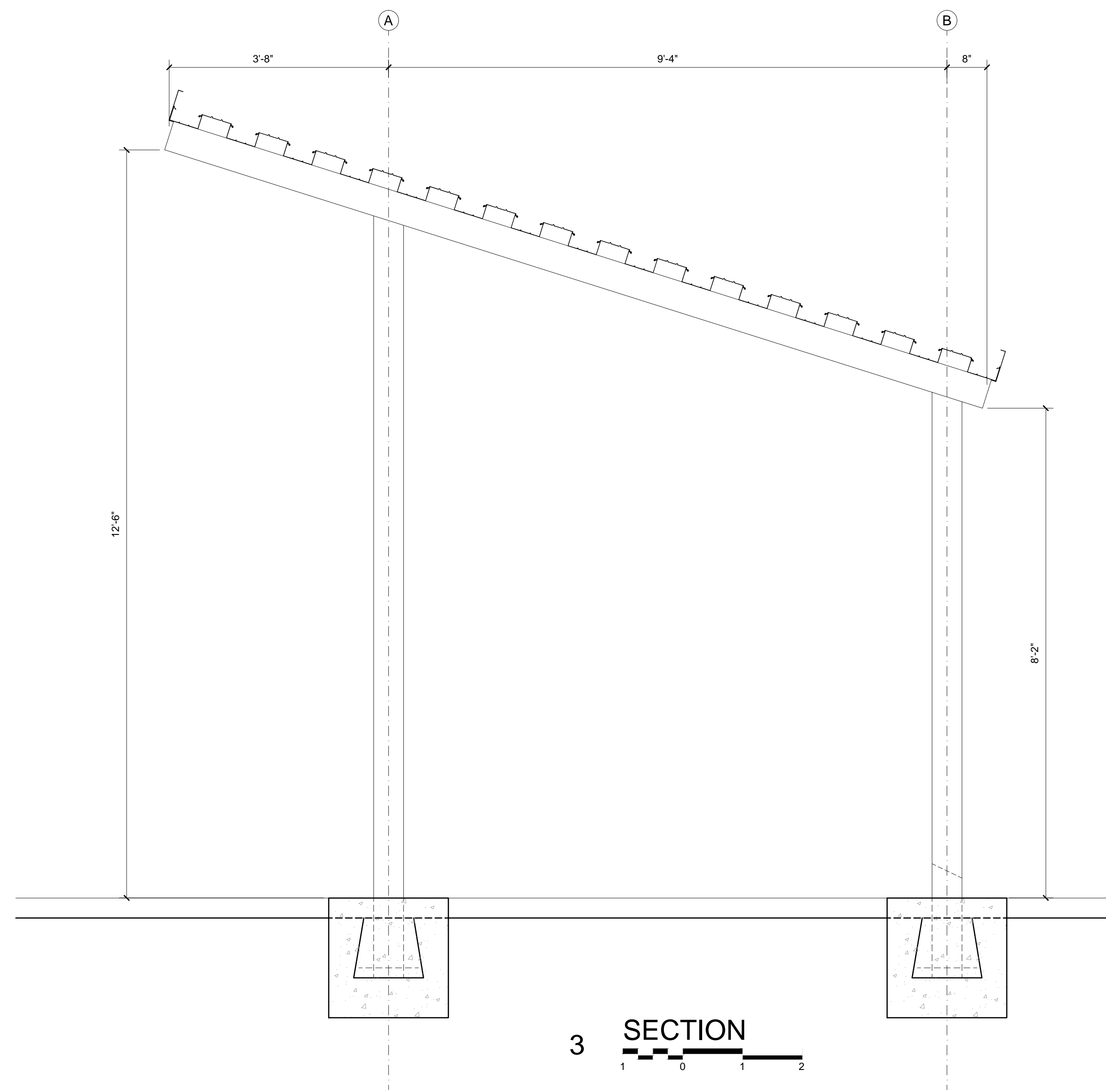

3 SECTION
1 0 1 2

PLANNING & ZONING DATA

OWNER: Buncombe County Board of Education
OWNER CONTACT: Tim Fierle, AIA - Director of Facilities and Planning
 Buncombe County Schools, 175 Bingham Road
 Asheville, NC 28806
PROJECT: (828) 255-5916
 Valley Springs Middle School Canopy
 224 Long Shoals Road, Arden, NC 28704
P.I.N.: 9644-69-3994
PROPERTY AREA: 58.11 acres
ARCHITECT: George A. Anderson III, AIA
 Alton Anderson Architecture
 12 Church Street
 Asheville, NC 28801
 Asheville City - INST

ZONING DISTRICT: Asheville City - INST

PARKING: Unchanged, No new parking required
IMPERVIOUS AREA: Unchanged
OPEN AREA: Unchanged

ALTON ANDERSON ARCHITECTURE
 A PROFESSIONAL CORPORATION
 12 Church Street, Suite 21
 Asheville, NC 28801

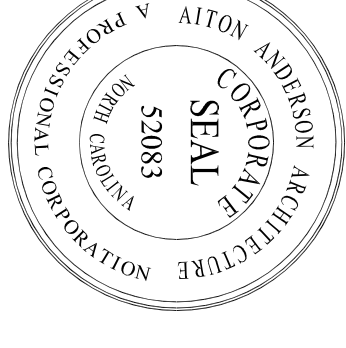

NEW CANOPIES FOR:
VALLEY SPRINGS MIDDLE SCHOOL
 224 LONG SHOALS ROAD
 ARDEN, NORTH CAROLINA

GEORGE A. ANDERSON
 REGISTERED ARCHITECT
 STATE OF NORTH CAROLINA
 LICENSE NO. 52083
 8/22/12
 Tripp Anderson, AIA
 828 989 5154
 ga@a@AltonAnderson.com

Issued for: **PERMIT**

Date: **9 OCT 2012**

Job #: **12300**

SITE PLAN

AS001

DRAWING INDEX

AS001 SITE PLAN
 A101 PLAN AND DETAILS

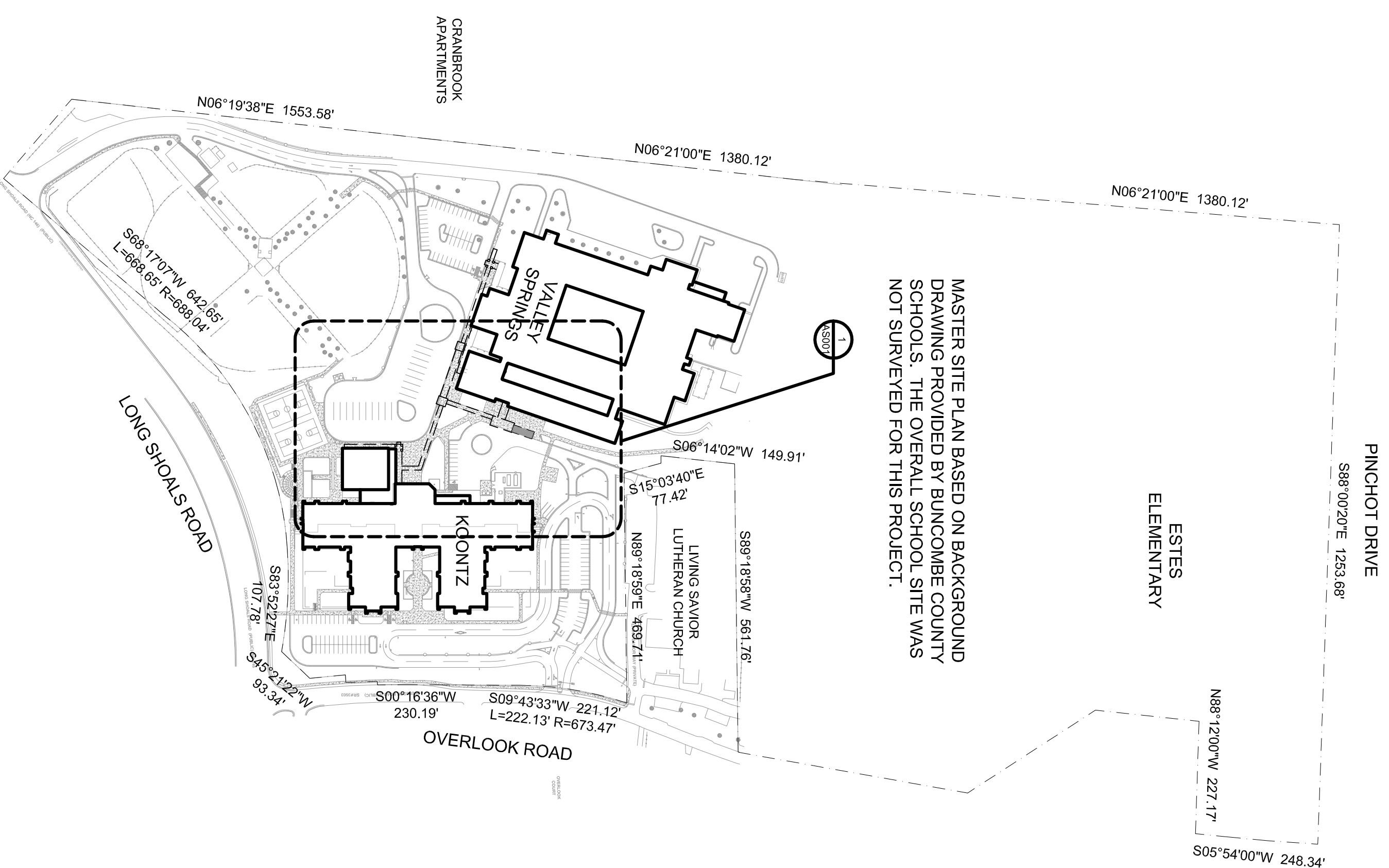
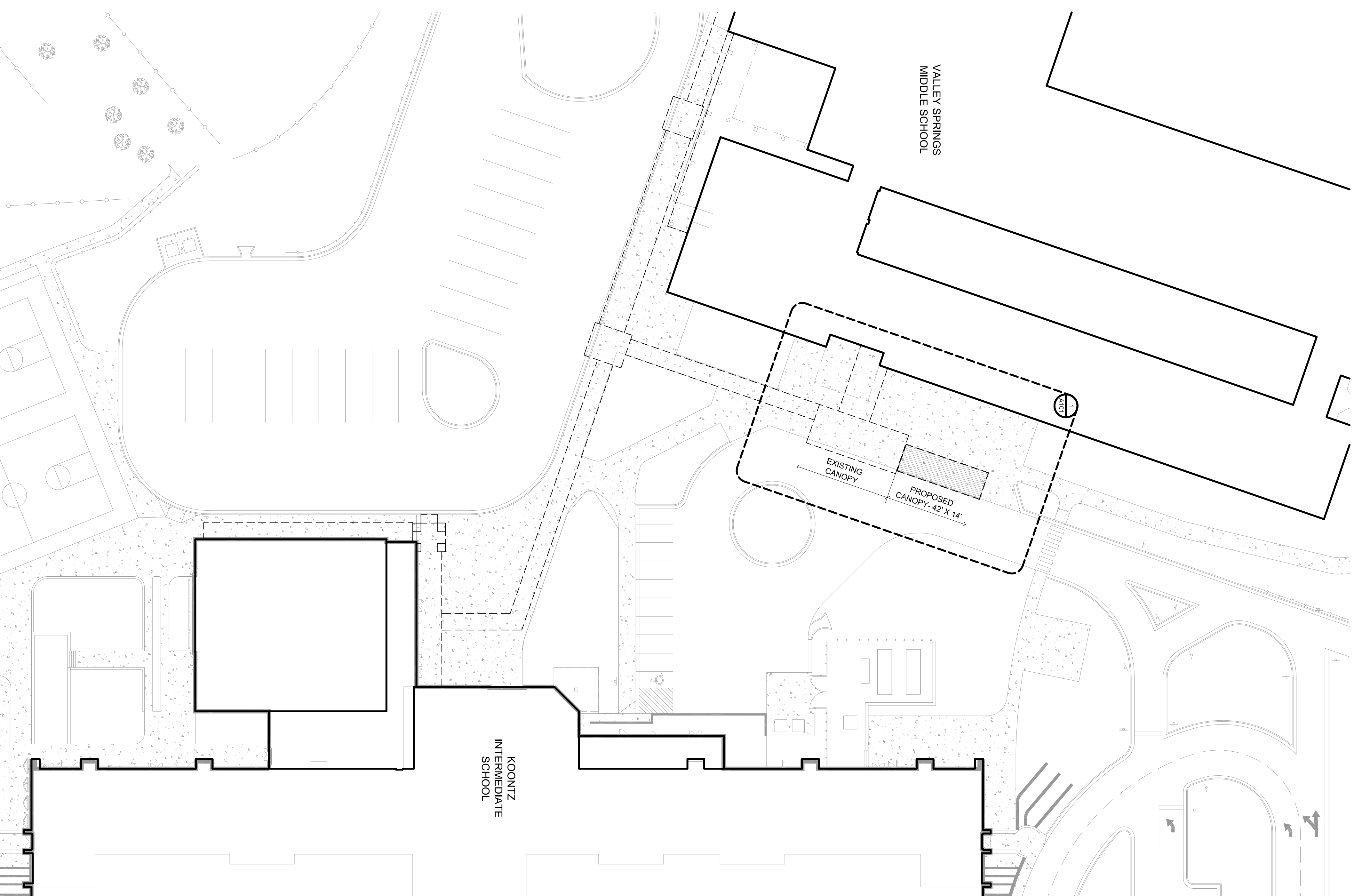

2 OVERALL SITE PLAN

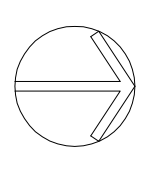

200' 100' 50' 0' 200' 400'

1 SITE PLAN

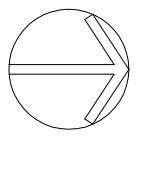

30' 20' 10' 0' 30' 60'

MASTER SITE PLAN BASED ON BACKGROUND DRAWING PROVIDED BY BUNCOMBE COUNTY SCHOOLS. THE OVERALL SCHOOL SITE WAS NOT SURVEYED FOR THIS PROJECT.