

SQUARE SCRUB®

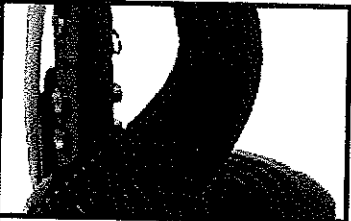

Register your product to receive
10% off your next order*

**3 Ways to Register your
Square Scrub Product:**

Online

<http://www.squarescrub.com>



Phone

800-557-6822

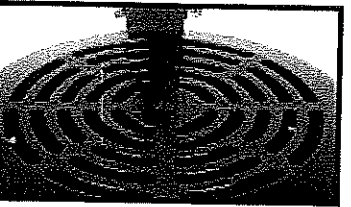

Mail (card enclosed)

P.O. Box 1693

Jonesboro, AR 72403

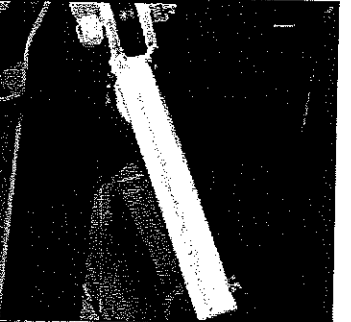

American Made

*\$100 minimum order. Credit card orders only.

SQUARE SCRUB®

Owner's Manual

EBG SERIES SURFACE PREPARATION MACHINES

EBG-20/Q • EBG-20/C • EBG-28
EBG-20/R • EBG-28/R

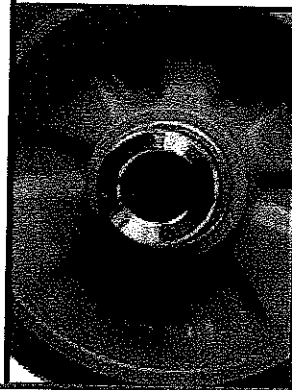
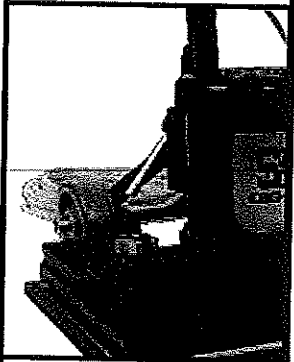
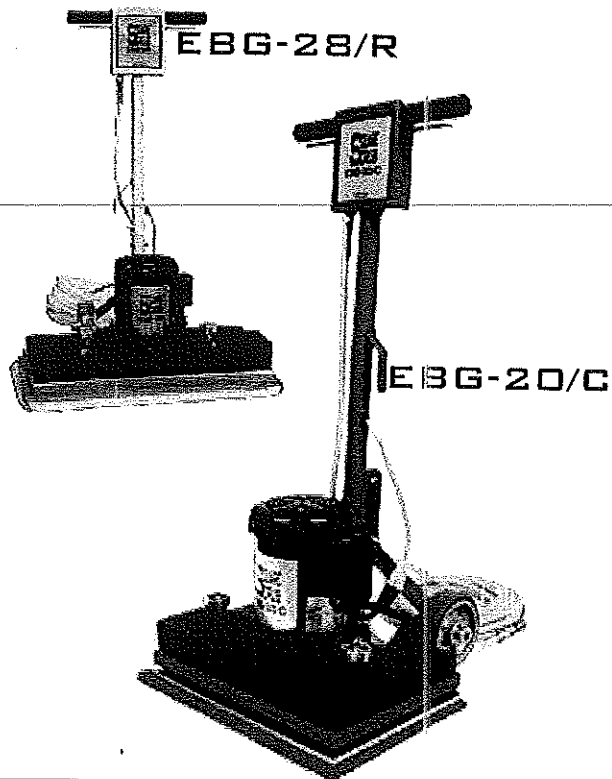

WWW.SQUARESCRUB.COM / 800.557.6822

SQUARE SCRUB EBG SERIES SURFACE PREPARATION MACHINES

Owner's Manual

About the Square Scrub Floor Surface Preparation Machine

Square Scrub's EBG machines are American Made. Our EBG Surface Preparation machines offer removable weights (optional on some models), a minimum 1.5hp, 1725rpm motor, powder coated 10 gauge steel, heavy duty frame, and 6"x2" non-marking ball-bearing wheels with a heavy duty 3/4" solid steel axle. Removable weights not only make our machine easy to transport but allow users to tailor the weight to suit their project needs.

With a selection of over 30 different surface preparation pads, there really is only one machine for the job. The Square Scrub EBG Surface Preparation Machines are designed to make the most efficient use of every pad, paper or screen used with the machine, saving both time and MONEY.

Please visit our Web site at www.squarescrub.com for informative videos and literature.

page 1



Contents

- Introduction
- Manual Conventions
- Safety / Important
- Machine Transport
- Operating Instructions
- Troubleshooting Guide
- Parts Breakdown
- Warranty Information
- Pad Information

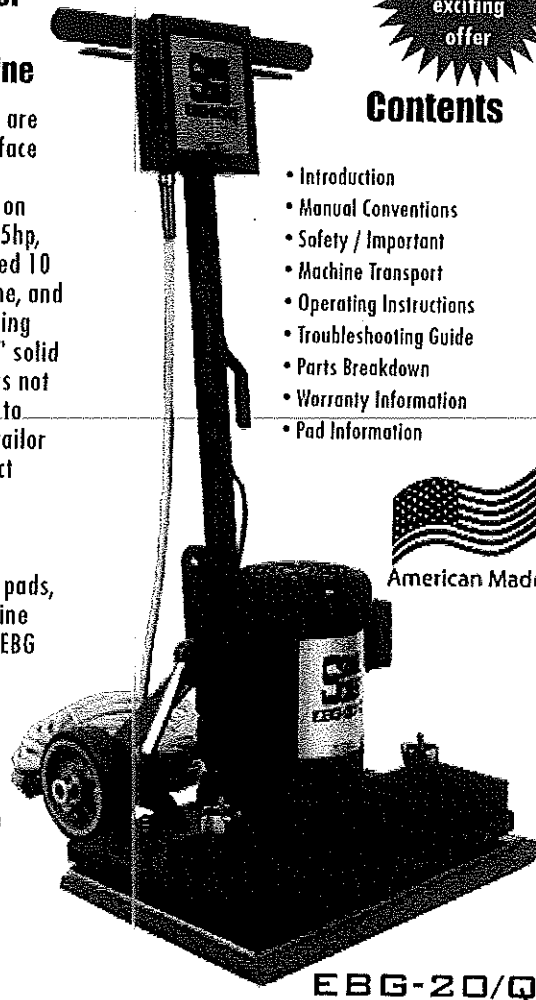

EBG-20/Q

Introduction

You are now the proud owner of an EBG-Series machine. This machine is a product of Square Scrub Inc. It is made of fine materials and will give you many years of satisfactory service if maintained and used according to the guidelines in this owner's manual.

Please read all Installation, Operation, and Safety Instructions before using this machine.

This product is for Industrial/Institutional/Commercial Use Only.

**WARNING OF POTENTIAL INJURY!
MOVING PARTS! UNPLUG BEFORE SERVICING!**

See back page for an exciting offer

This product contains moving parts. To reduce the risk of injury, unplug before servicing.

General Safety

- This floor-finishing machine shall be grounded while in use to protect the operator from electric shock. The machine is provided with a three-conductor cord and a three-contact grounding type attachment plug to fit the proper grounding type receptacle. The green (or green and yellow) conductor in the cord is the grounding wire. Never connect this wire to anything other than the grounding pin of the attachment plug.
- This machine is for use on a nominal 120-volt circuit and has a grounding plug that resembles the plug in figure 1. Make sure that the machine is connected to an outlet having the same configuration as the plug.

No adapter should be used with this machine.

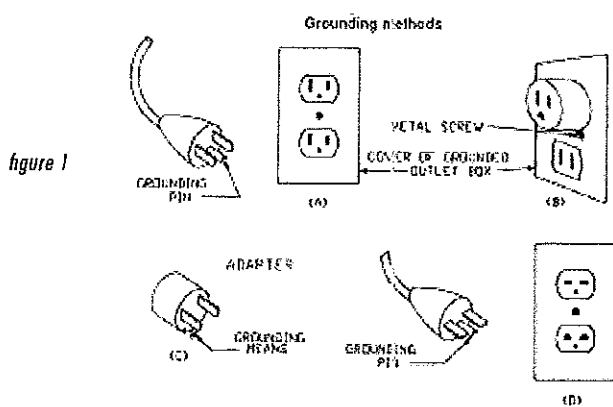

Manual Conventions

Danger: Indicates an imminently hazardous situation which, if not avoided, may result in death or serious injury.

Caution: Indicates that machine or property damage could result if instructions are not followed.

Note: Provides helpful information.

Severe bodily injury or death can occur to you or other personnel if warnings found on this machine or in this owner's manual are ignored. Read and observe all statements and instructions found on the machine and in the owner's manual.

Who to call for assistance

If you work with a Square Scrub-authorized distributor, contact them for assistance.

If any contents of the box are missing, contact your Square Scrub-authorized dealer, distributor or reseller. If you purchased your machine directly from Square Scrub, contact Square Scrub at 1.800.557.6822 for service in the United States and Canada. For worldwide service, call Square Scrub directly at 870.930.9898. Make sure you have the machine's serial number, located on the back of the machine, when you call.

Liability statement

This Square Scrub product has been built to the highest industry standards. Please note and heed the WARNING and CAUTION labels that have been placed on the equipment and in this manual for your safety. PLEASE DO NOT ATTEMPT TO OPERATE OR REPAIR THIS EQUIPMENT WITHOUT ADEQUATE TRAINING. ANY USE, OPERATION OR REPAIR IN CONTRAVENTION OF THIS DOCUMENT IS AT YOUR OWN RISK. BY ACCEPTANCE OF THIS SYSTEM YOU HEREBY ASSUME ALL LIABILITY CONSEQUENT TO YOUR USE OR MISUSE OF THIS EQUIPMENT. SQUARE SCRUB SHALL NOT BE LIABLE FOR ANY INCIDENTAL, INDIRECT, SPECIAL OR CONSEQUENTIAL DAMAGE OF ANY KIND.

Equipment specifications, applications and options are subject to change at the sole discretion of Square Scrub without notice.

Safety

All Square Scrub products are built to strict safety and reliability specifications in accordance with industry standards. Therefore, safety issues pertaining to operation and repair of Square Scrub equipment are primarily environmental and human interface. The following basic safety tips are given to ensure safe installation, operation and maintenance of Square Scrub.

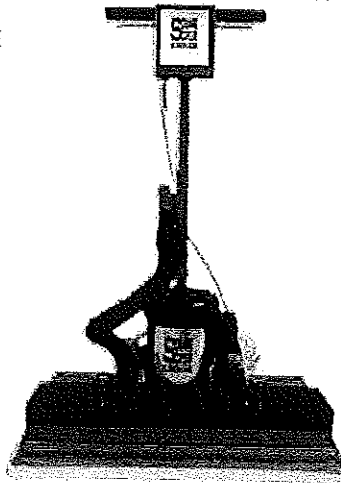

Important

- Never leave the machine unattended while power cord is connected.
- Always wear personal protective equipment (PPE) when operating this machine.
- Never inhale dust created by the use of this machine. Any modifications to this machine may result in damage to the machine or injury to the operator or others nearby. Alterations to the machine will also void any and all warranty and liabilities.
- Sanding wood decks is not recommended by Square Scrub due to uneven surfaces which could lead to damage to the machine. Some pressure treated wood found in decking contains arsenic that, when sanded, will create hazardous dust. Square Scrub assumes no liability if the machine is used on decks, and damage caused from sanding pressure treated wood will not be warranted.
- Do not operate this machine around fuels, solvents, flammable floor finishes, thinners, wood particulate or any flammable materials. Cigarette lighters, pilot lights, electrical sparks and all other sources of ignition should be extinguished or avoided. Work areas should be well ventilated.



PPE Equipment

- Keep the power cord clear of the pad. Always lift the cord over the machine. Do not pull on the power cord in an attempt to move the machine. This could result in electrocution.
- Do not use machine if it has been sprayed with water or left out in the rain. This could result in a shock injury or electrocution.
- Keep feet, hands, and loose clothing away from any moving parts on the machine to avoid injury. Disconnect power cord before changing the pad or when servicing. Damage can occur to the machine or to other property if instructions in the owner's manual are not followed.
- Do not operate this machine while under the influence of alcohol or other drugs.
- Never allow children under age 18 to operate this machine.
- Unplug machine from power source before adjusting height of handle or changing pad.
- Servicing this machine while still connected to a power source could lead to electrocution or fire. Before performing machine service or maintenance, disconnect the machine from its power source.
- Operating this machine with a damaged power cord could lead to electrocution or fire. Cord should remain clear of moving parts during operation. Never use the cord to navigate the machine.



Transport of Machine

To transport this machine, the following procedure is advised:

- Unplug machine from power source.
- Always leave a pad on the machine to protect the grip face from damage in transport and storage.
- Wrap cord using cord wrap and handle.
- Raise handle adjustment lever and lock into the transport notch in an upright position.
- Tilt machine onto wheels and transport slowly.
- Square Scrub recommends a two-person lift when picking up the machine. With one user on each side of the machine, place one hand on machine axle and one hand around the front base of the machine. Lift machine, making sure to bend at the knees.
- Secure machine when transporting in a vehicle to prevent movement.

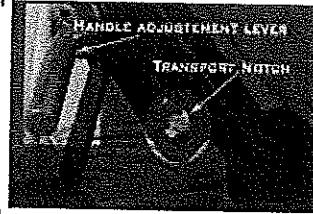

Caution: This machine is very heavy. Get assistance when lifting. Do not attempt to lift alone.



General Operating Instructions

1. Move machine to work location. Never operate, transport, or store the machine without a pad to protect the grip face.
2. Plug machine into grounded power outlet.
3. Stand behind the Square Scrub and place your hands on the padded grips.
4. Gently squeeze the coated metal handle underneath the hand grips to engage the motor. Depending on the pad configuration, the machine may initially pull in one direction. This is normal and you will be able to quickly steady the machine.
5. Begin moving forward in straight lines.
6. If the handle is too tall, disengage the handle lock mechanism and slide the handle toward you until you find a comfortable height. Lock the handle into that position either with your hand or press firmly with your foot.
7. Continue moving in straight lines, checking your pad every 15 to 30 minutes (depending on pad in use) to maintain optimum performance.



Maintenance Schedule

Prior to using (daily)

- Check AC power cord. Do NOT operate equipment if AC power cord is cut, frayed or if ground is missing.
- Check vacuum hose and connections (if equipped).
- Check grip face and driver pad : inspect for wear / debris. Replace as needed.

After use (daily)

- Clean pad and base plate assembly : remove/replace pad as needed.
- Inspect grip face for wear. Remove debris between grip face and base plate.
- Wipe base plate and motor assembly with damp microfiber cloth.
- Make certain a pad is placed on grip face.

Weekly PM

- Check grip face for wear.
- Use vacuum to clean away debris build-up around motor assembly, weights and base plate.

Annually

- Replace ALL isolators.

Maintenance Info

Remove and Replace Isolators on the Square Scrub

1. Make certain the machine is unplugged.
2. With machine upright, use a 5/32" Allen wrench to remove four bolts holding the "U" shaped handles from the deck of the machine and the weights. If your machine has removable weights with the star-shaped nuts, simply unscrew and remove the weights.
3. Remove the four 7/16" inch nuts that were exposed once the weights were removed. A socket or standard box-end wrench will work.
4. Once removed, gently tilt the machine backwards onto its handle, exposing the under side of the machine.
5. Remove the pad from grip face and set aside
6. Square Scrub recommends removing the eight 5/32" Allen head bolts from around the center perimeter of the base plate. (Optional : If your machine is relatively clean and free of heavy debris, you can remove the center 7/16" bolt, but only if it appears to be easily removed).
7. Once all eight Allen head bolts are removed the bottom plate can be taken off the machine.



Isolator Repair Kit

8. Remove the old isolators with a 3/16" Allen wrench. (NOTE : ALWAYS replace all isolators at the same time)
9. Your isolator replacement kit will have new bearing bolts. NEVER re-use bearing bolts. Once all isolators are removed, discard the old isolators and bearing bolts.
10. Once you have replaced all four isolators (or eight if EBG-28), you are ready to put the plate back onto the base of the machine. Take care at this point to carefully line up the isolator male stud with the holes on the base of the machine to avoid damaging the bolt.
11. Rotate the center bolt clockwise until the threaded bolt holes line up to allow the Allen head bolts to be installed.
12. Use a small amount of Blue Loctite (provided in your kit) to each bolt thread.

Note: Use Blue Loctite ONLY (included in the kit)



13. Install each Allen head bolt one-by-one, but do not tighten down until ALL eight bolts are inserted.
14. Once all eight Allen head bolts are inserted, tighten until firm.
15. Place the pad back onto the grip face of the machine and return the machine to an upright position.
16. Replace the four (or eight for EBG-28) 7/16" nuts on the top of the isolator bolts and tighten.
17. Replace the weight(s) back onto the machine in preparation of replacing the handles. If your machine is equipped with removable weights, simply place the weights back on the machine and tighten the star nut back over the threaded rod.
18. Replace handles and spacers. Replace four 5/32" Allen head bolts back into holes and tighten.
19. You're now finished with replacing your isolators!

Tools Needed

Isolator Repair Kit

3/16" Allen wrench 5/32" Allen wrench

7/16" socket/driver (optional) 7/16" wrench

Replace your isolators once per year unless you experience heavy use, then replace every three months. This will help keep your Square Scrub running great for years!

How-To Replace the Grip Face on Your EBG Machine

Tools needed include: Pliers/vise grip, paint thinner, gloves, mask, hi-grade alcohol, putty knife, large towel, small rag or paper towels

1. Ensure machine is unplugged, tilt machine back on its handle, then remove the pad attached to grip face.

2. With vise grips (best) or pliers, grab a corner of the grip face and aggressively pull diagonally. Once started, use the putty knife with one hand to dislodge from the baseplate while pulling with the vise grips.

3. After the entire grip face is removed, you can continue to scrape excess glue with the putty knife. Square Scrub recommends lightly soaking a large towel in paint thinner and setting the machine on the towel for 15 minutes. If you follow this step, the adhesive will easily scrape off with the putty knife.

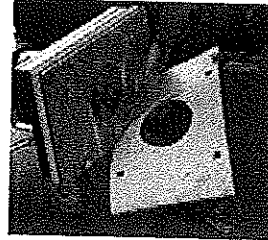

Warning: Follow manufacturer's safety guidelines when using harsh chemicals like paint thinner and hi-grade alcohol. Keep away from flames. Use in a well ventilated area and wear a mask, rubber gloves and long sleeves while using chemicals.

4. Ensure the baseplate is completely clean and free of debris by wiping thoroughly with hi-grade alcohol

5. Remove plastic film from the back of the new grip face. Avoid touching with your fingers as the exposed adhesive is very sticky.

6. Align the new grip face with the baseplate and firmly press onto baseplate. Apply firm pressure all over the grip face to ensure maximum adhesion to the baseplate.



And you're done! There is no cure time for the adhesive to set and your Square Scrub is ready to work.

Note: Return the pad to the new grip face and set the machine upright.



SQUARE SCRUB

EBG-20 PARTS LIST

THIS IS FOR ILLUSTRATIVE PURPOSES ONLY
DO NOT USE FOR PART ORDERING

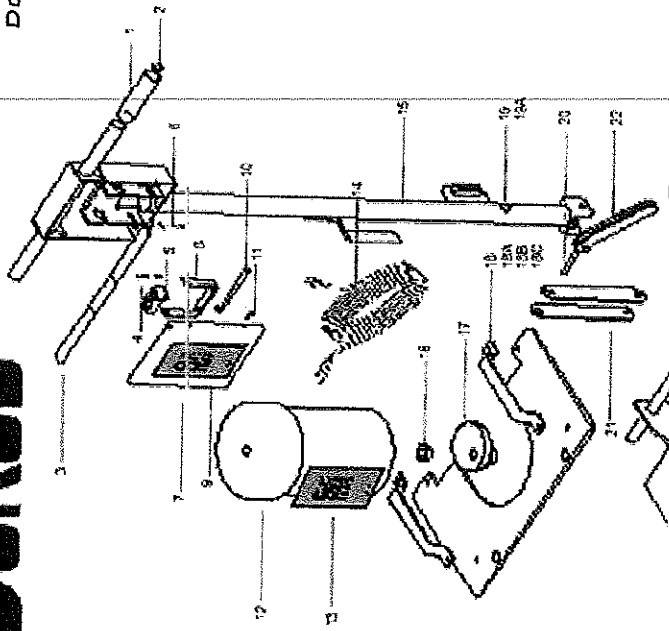

REF #	DESCRIPTION	QTY
1	HAND GRIP	2
2	HANDLE PLUG	2
3	SWITCH BAR	1
4	SWITCH SPRING	2
5	MICRO SWITCH	1
6	CORD STRAIN RELIEF	1
7	SWITCH COVER	1
8	SWITCH ACTUATOR	1
9	SWITCH COVER DECAL	1
10	SWITCH ACTUATOR BOLT & NUT	1
11	SWITCH COVER SCREW	4
12	MOTOR ASSY.	1
13	MOTOR DECAL	1
14	POWER CORD ASSY	1
15	HANDLE*	1
16	MOTOR SHAFT SPACER	1
17	ECCENTRIC	1
18	LIFT HANDLE	2

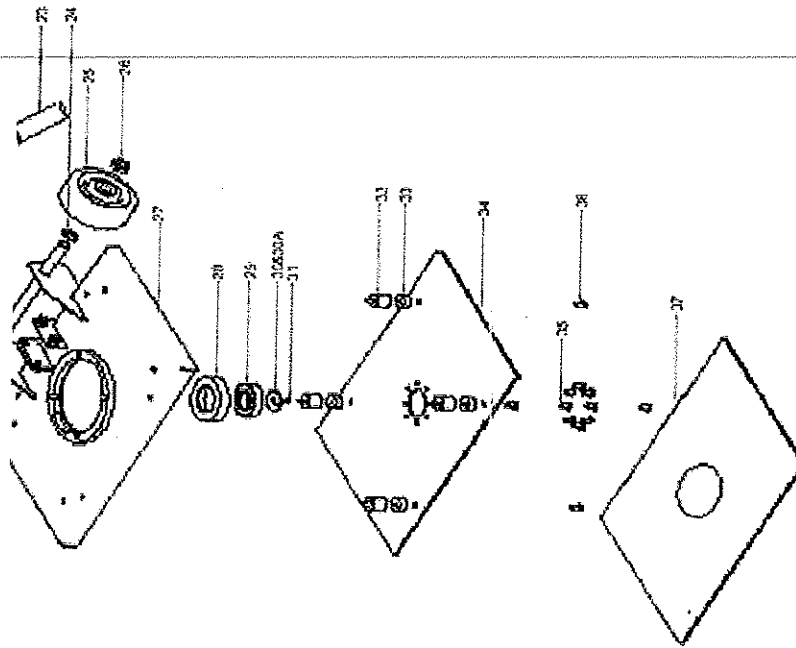

18A	LIFT HANDLE SCREW	4
18B	LIFT HANDLE SPACER	4
18C	FRONT WEIGHT	2
19	GROMMET	1
19A	HANDLE CORD ASSY	1
20	HANDLE LOCK EYE BOLT	1
21	HANDLE LOCK STAY	2
22	HANDLE LOCK HANDLE	1
23	HANDLE LOCK COVER	1
24	AXLE WAVE WASHER	2
25	WHEEL	2
26	AXLE COLLAR	2
27	MACHINE BASE*	1
28	BEARING CLIP	1
29	BEARING	1
30	CRUSH WASHER	1
NOT SHOWN ON BREAKDOWN		
30A	LOCATOR PIN	1
31	MOTOR BOLT	1
32	RUBBER ISOLATOR KIT (4EA)	1
33	RUBBER ISOLATOR SPACER	4
34	ALUMINUM PAD DRIVER	1
35	BEARING CLIP BOLT	8
36	RUBBER ISOLATOR BOLT	4
37	PAD GRIP FACE	1

18A	
18B	
18C	
19	
19A	
20	
21	
22	
23	
24	
25	
26	
27	
28	
29	
30	
30A	
31	
32	
33	
34	
35	
36	
37	

SQUARE SCRUB, INC. 800-557-6822
 WWW.SQUARESCRUB.COM

Troubleshooting

Problem	Cause	Action
Machine will not start	Not Connected to power source Voltage too low Defective switch	Check power source connection and lighted plug Have electrician check outlet Contact Square Scrub dealer
Runs erratically	Low voltage from excessive length or undersized extension cord Defective start switch Defective motor low voltage	Use 10 gauge extension cord Not more than 25' long Contact Square Scrub dealer Contact Square Scrub dealer
Fuse/Circuit Breaker Trips	Low voltage Low input volts	Allow the motor to cool. The circuit breaker is a red button on the side of the motor that will reset when pressed. Eliminate extension cord. Locate power cord closer to work site. Have voltage checked by electrician.
Machine pulls hard to one side <small>Note: The rubber isolators on the EBG are considered wear items. It is recommended to replace the entire set of all four isolators once per year to prevent failure and damage to the machine.</small>	Worn Pad Rubber isolators are worn out	Rotate pad 180 degrees Flip pad over Replace isolators
Machine is noticeably louder than it was when originally purchased	Rubber isolators worn Removable weights not secured	Replace isolators Tighten star knobs on removable weights



Scrubbing Pads

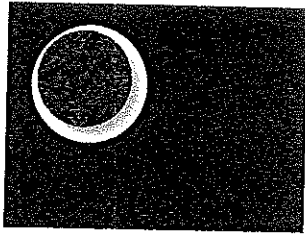

SQP
20 - P1420SQP
28 - 1428SQP

SQP is a thin pad designed to remove floor finish without chemicals. Remove several layers of acrylic finish to prep for recoating. **Use dry** on VCT and tile. 10/Case

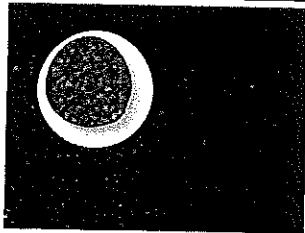

Tile and Grout Pad
20 - P1420TG
28 - P1428TG

Our Tile and Grout pad is best on grouted tile floors, but can be used very effectively on terrazzo, poured non-slip, concrete and other uneven floors. **Use wet** on several surfaces. Each

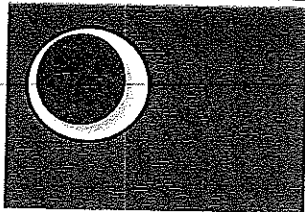

Red Pad
20 - P1420RED
28 - P1428RED

This light duty Red pad gives best results in a light cleaning and buffing situation. Primarily used as a spacer pad. **Use wet or dry** on VCT and tile. 5/Case

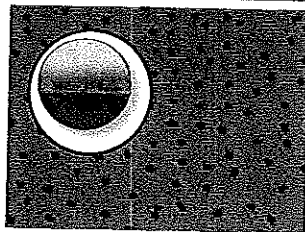

SAP - Square Abrader Plate
20 - P1319SAP
28 - P1327SAP

Carbide Tungsten steel abrader tool. Designed for heavy duty use, including linoleum, glue or paint on concrete. **Use dry** on concrete. Each

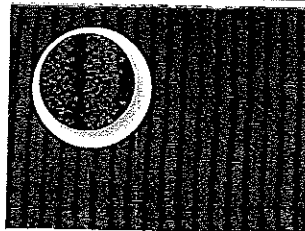

Carpet Bonnet
20 - P1420CB

Combined with our carpet encapsulation chemical, the Carpet Bonnet deep cleans even the highest-traffic carpeting. Quicker drying time. **Use wet** on any carpeted surface. *For 20-inch machines only* Each

Scrubbing Pads / Sandpaper

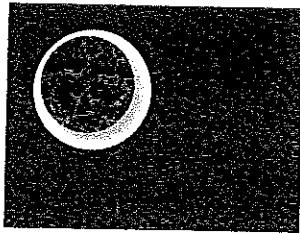

SHO Wet Strip Pad
20 - P1420SHO
28 - P1428SHO

The SHO pad should be used only for the heaviest of chemical stripping jobs. Extremely abrasive and heavy, dense fibers. Best when dirt and buildup are severe. Use wet on VCT and tile. 5/Case

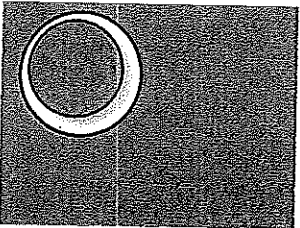

SSE - Enhancer Pad
20 - P1420SSE
28 - P1428SSE

The SSE (Enhancer pad) is designed exclusively for Square Scrub to be used as restorative pad used with Square Shine Floor Reviver. Use wet on VCT and tile 5/Case

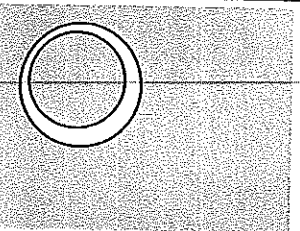

Xtreme Sponge
20 - P1420XTR
28 - P1428XTR

Use the Xtreme Sponge to remove scuff marks on VCT or bathroom tile. A little water and this melamine pad deep cleans and restores shine between refinishing jobs. Use wet on VCT and bathroom tile. 10/Case

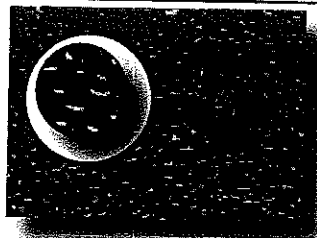

Pro

20-inch		28-inch	
Grit	item#	Grit	item#
16	PPSP1319016	16	PPSP1327016
24	PPSP1319024	24	PPSP1327024
36	PPSP1319036	36	PPSP1327036
60	PPSP1319060	60	PPSP1327060
80	PPSP1319080	80	PPSP1327080
100	PPSP1319100	100	PPSP1327100

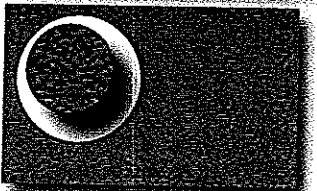

Sandpaper

20-inch		28-inch	
Grit	item#	Grit	item#
20	SP1319020	20	SP1327020
36	SP1319036	36	SP1327036
60	SP1319060	60	SP1327060
80	SP1319080	80	SP1327080
100	SP1319100	100	SP1327100

Screens / Stone Prep Pads

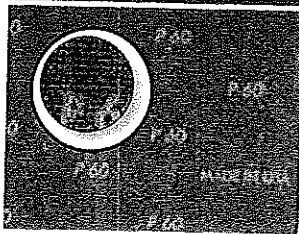

10/Case

Sandscreens are ideal for finish removal or repair of wood floor surfaces, such as gym floors. Can be used to repair painted floor surfaces. Both sides of screen can be used. Use with Red Driver Pad P1420RED. Use wet or dry on wood or painted concrete.

EBG-20

60 S1420060
80 S1420080
100 S1420100
120 S1420120
150 S1420150

EBG-28

60 S1428060	120 S1428120
80 S1428080	150 S1428150
100 S1428100	180 S1428180

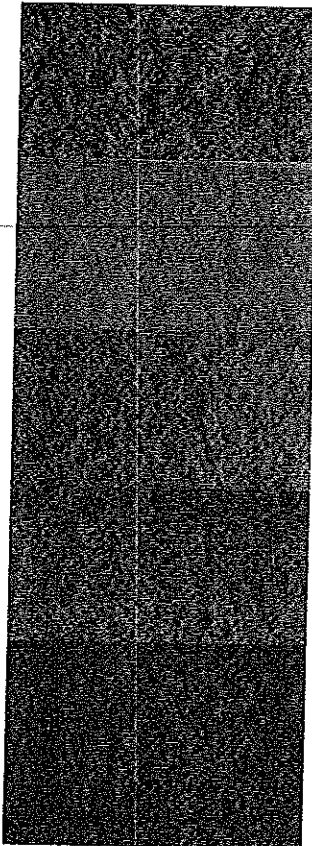

PSP1420BLK

For heavy duty cleaning of stained and dirty industrial coatings and raw concrete. Removes oil, grease, soot, and tire marks. 100 grit. Use wet or dry on concrete 2/Case

PSP1420RED

The Red PSP is best used on worn concrete for heavy duty cleaning. Will remove scratches and stains from the surface. 400 grit. Use wet or dry on concrete 2/Case

PSP1420WHT

A smooth finish will be the result of using the White PSP. Removes heavy scratches from the surface. 800 grit. Use wet or dry on Terrazzo, natural stone, concrete, vinyl and epoxy 2/Case

PSP1420YLW

The Yellow PSP is used for polishing, thanks to the 1500 grit rating. Helps restore luster to dull surfaces. Use wet or dry on Terrazzo, natural stone, concrete, vinyl and epoxy 2/Case

PSP1420GRN

Use the Green PSP when you're ready to put a high gloss shine on stone, vinyl, linoleum, smooth concrete, terrazzo and natural stone surfaces. 3000 grit. Use wet or dry. 2/Case

All five models represented on this chart feature
 removable weights
 one-year limited warranty on parts and
 labor
 two-year limited manufacturer's warranty
 on the motor

Technical Information	EBG-20/Q	EBG-20/C	EBG-28	EBG-20/R	EBG-28/R
Base w/no weights or handle	73lbs	73lbs	81lbs	73lbs	81lbs
Total assembled weight	121lbs	158lbs	271lbs	158lbs	271lbs
motor (1.5 hp)	1725 rpm	3450 rpm	3450rpm	3450 rpm	3450 rpm
50 foot 14 gage hospital grade power cord	✓	✓	✓	✓	✓
Operating sound output	62db	73db	73db	73db	73db
10-gauge powder coated steel frame	✓	✓	✓	✓	✓
3/4" solid steel axle	✓	✓	✓	✓	✓
6"x2" non-marking wheels w/ball bearings	✓	✓	✓	✓	✓
Adjustable handle w/transport lock	✓	✓	✓	✓	✓
Pad size	14x20	14x20	14x28	14x20	14x28
Lighred plug	✓	✓	✓	✓	✓
Built-in hour meter	optional	optional	optional	✓	✓
Dust containment kit	optional	optional	✓	✓	✓
Two-piece handle	optional	optional	optional	✓	✓
Isolators	4	4	8	4	8

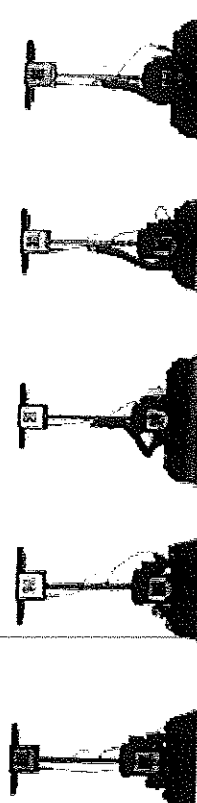

Square Scrub Limited Warranty

This Square Scrub product is warranted to be free from defects in materials and workmanship under normal use and service for a period of one year from the date of purchase, when operated and maintained in accordance with Square Scrub Maintenance and Operating Instructions. Damage due to misuse or improper care will not be repaired under warranty.

This warranty is extended only to the original purchaser for use of the product. It does not cover normal wear and tear parts such as electrical cable, rubber parts, pad driver and motor brushes.

Note: The rubber isolators are considered wearable parts. It is recommended that the entire set of four (or eight on EBG-28) isolators be replaced every year, regardless of the number of hours operated.

If a difficulty develops with the product, contact your local Square Scrub dealer or call Square Scrub at 800.557.6822. Only Square Scrub can authorize repairs under warranty.

Transportation charges to and from the repair location, including motors still under warranty, will be paid or prepaid by the purchaser. Freight charges on parts are not included. The purchaser will bear full financial responsibility for any freight, testing and assembly if the warranted Square Scrub or motor is found to be defect-free.

Square Scrub's liability under this warranty is limited to repair of the product and/or replacement of parts and is given to purchaser in lieu of all other remedies, including INCIDENTAL AND CONSEQUENTIAL DAMAGES.

THERE ARE NO EXPRESS WARRANTIES OTHER THAN THOSE SPECIFIED HEREIN. THERE ARE NO WARRANTIES WHICH EXTEND BEYOND THE DESCRIPTION OF THE FACE HEREOF. NO

WARRANTIES, INCLUDING BUT NOT LIMITED TO WARRANTY OF MERCHANTABILITY, SHALL BE IMPLIED.

Please register your machine on our website within thirty (30) days of purchase to assist Square Scrub in providing the performance you expect from your new floor machine.

Square Scrub
800-557-6822
www.squarescrub.com

Machine Serial #: _____

Date of Purchase: _____

